



METRO

Luminaire design: Eclatec

METRO sets the tone in a magic partition.

Behind this note, this line, this arc, this outline lives a soul, that invites composition; in fact, METRO knows how to surround itself with a variety of cross-arms in unison with its sweet melody.

METRO, in these combinations, provides the up-to-date and lively tempo that, mutedly, accompanies the urban symphony.



ORALED MODULE



SEOLED MODULE



INTEGRATED BLS STRIPS



Metro on Gem bracket



Metro on Pyramid bracket



Metro on Tecla bracket

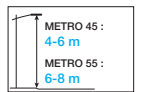

METRO 45 With SEOLED 1 module



METRO 55 With ORALED 2 module



APPLICATIONS

- Mounting: suspended from a ball or a catenary
- Metro 45: Pedestrian areas, cycle paths, residential areas, street lighting
Metro 55: Roads, secondary urban and inter-urban streets
- Recommended heights: Metro 45: 4 to 6 m / Metro 55: 6 to 8 m

DESCRIPTION

- Luminaire available in 2 sizes: Metro 45 and Metro 55
- Spun aluminium body
- Injection die cast aluminium frame and upper swivel joint
- Polyester powder coating, any colour available
- IP 65
- Class I or II
- 2 types of sources:

ORALED 1 and 2 module:

- equipped with an **ORALENS** mono lens in PMMA/IK 08,
module colour grey 2150 sanded or 2900 sanded
- colour temperature: 4000 K and 3000 K

SEOLED 1 and 2 module:

- equipped with BLS with **QUADRALENS** lenses and glass bowl/IK 08,
module colour grey 2150 sanded or 2900 sanded
- colour temperature: 2400 K, 2700 K, 3000 K or 4000 K

CITIZEN REFERENCE POINTS

- Materials used:
 - Metro 45: Aluminium 83%, Other 13%, Plastic 4%
 - Metro 55: Aluminium 86%, Other 10%, Plastic 4%
- Complies with the RoHS directive
- High recyclability rate

WATERPROOFING

- IP 66 waterproofing in accordance with the standard EN 60 529
- Pneumatic silicone gasket

MECHANICAL INTERFACES

- LRM: Metro Smooth Lateral Ball with wrapping sleeve for the end of the cross-arm
Ø 60 mm and Ø 42 mm outside
- SRL: Metro suspended with plain swivel joint coupled with sleeve for bracket end
external Ø 60 mm (see page 278 - E, F)
- SR: suspended from a ball (see page 278 - H)
- SM: Metro suspended with 3/4" BSP adapter for female boss welded to bracket
(see page 278 - H)
- CATELUX: Metro with SM Ø27 pdg fixation
Fixation on 5 to 14 mm diameter mechanical cable
- SCO: Metro catenary version
Fixation on 5 to 14 mm diameter mechanical cable



SRL

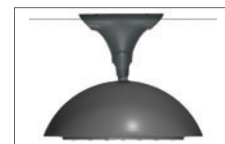

Catelux



SM



SCO

PHOTOMETRIC DISTRIBUTIONS

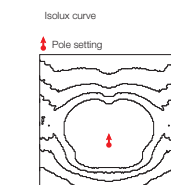
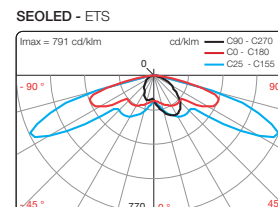
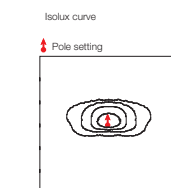
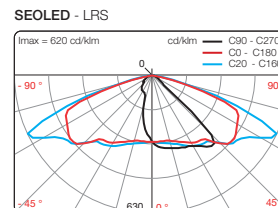
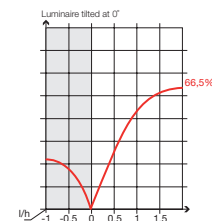
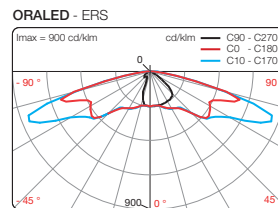
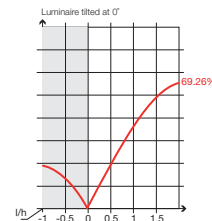
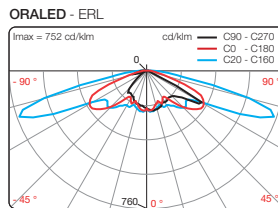
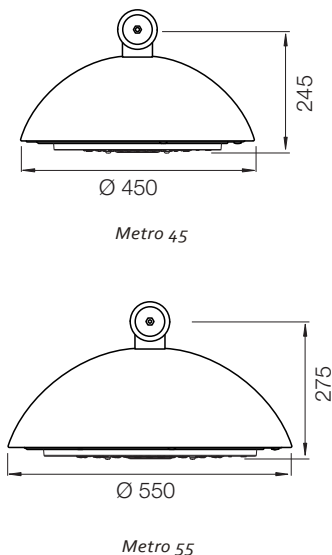

KEY POINTS

	METRO 45	METRO 55	
Applications	Pedestrian areas, cycle paths, residential areas, street lighting	Roads, secondary urban and inter-urban streets	
Recommended heights	4 to 6 m	6 to 8 m	
Mounting	See Mechanical interfaces		
Dimensions	\varnothing height		
	465 mm 245 mm	565 mm 275 mm	
Weight	6,6 kg	9,3 kg	
Windage area	0,06 m ²	0,09 m ²	
Sources	ORALED 1 SEOLED 1	ORALED 2 SEOLED 2	
Sources access	Removable ORALED and SEOLED modules		
Optics and light distribution options	ORALENS: ERS, ERL, ECL, LRM QUADRALENS⁽¹⁾: ERS, ERL, ERE, LRS, LRL, PFA, EPD, EPG, ETS, ECa	ORALENS: ERS, ERL, LRM, LRE QUADRALENS⁽¹⁾: ERS, ERL, ERE, LRS, LRL, PFA, ECa	
Power supply current (mA)	100 to 700 mA		
OPTIONS	Backlight shield⁽¹⁾ (factory or site assembly)	<input type="radio"/>	<input type="radio"/>
	SMART-READY⁽²⁾ by Eclatec (construction)	<input type="radio"/>	<input type="radio"/>
	DALI (construction)	<input type="radio"/>	<input type="radio"/>
	Dimming 5 (preset)	<input type="radio"/>	<input type="radio"/>
	CLO (preset)	Compatible with standard version, Dimming 5, Motion 5 or DALI option	
	Motion (setting on site)	<input type="radio"/>	-
	Motion P (set in the bottom of the pole)	<input type="radio"/>	<input type="radio"/>
	Motion 5 (setting on site)	<input type="radio"/>	-
Motion COM (setting on site)	<input type="radio"/>	-	
POLEDRIVE (set in the bottom of the pole)	<input type="radio"/>	<input type="radio"/>	

(1) Backlight shield optional except for EPD, EPG, ECa

(2) Preconfigured communicating system: Wired Sensor Ready type driver and Zhaga consortium base. Be sure to hold the connector when installing the module

Glossary:

- Standard
- Option
- Not available

E/L/P: Lighting/Luminance/Projection, **R/C/T/F/P:** Road/Circulation/Path/Beam/Pedestrian walkway, **E/S/L/A/D/G:** Narrow/Standard/Wide/Asymmetric/Right/Left, **POLEDRIVE:** preset at the bottom of the pole / night dimming calculator with 2 configurable thresholds, set in the bottom of the pole, **Dimming 5:** night dimming calculator with 5 configurable thresholds, **Motion:** moving sensor, **Motion P:** Configurable offset presence detector at the foot of the pole, **Motion DALI:** Detector integrated to the luminaire, adjustable at pole base, **Motion 5:** Motion sensor and dimming calculator, **Motion COM:** Wireless detection and communication, **DALI:** compatible with the DALI protocol, **CLO:** Constant Lumen Output option

BACKLIGHT SHIELD

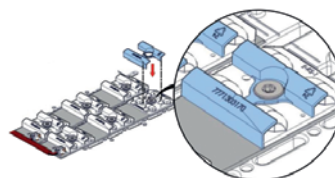

Backlight shield SEOLED version

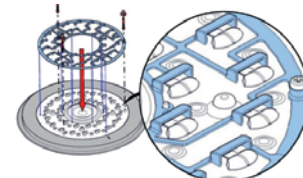

Backlight shield ORALED version

MAINTENANCE

Opening and closing

Opening of the luminaire by 3 quarter-turn screws. The module swivels around a hinge in aluminium.



LED module maintenance

Direct access to the module, removable. Power supply by quick connectors.

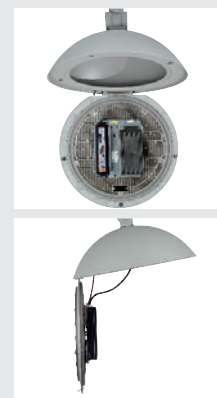

LED Luminaires

Modern Streetfurniture

Waste bins

Bollards Light

tree grill

Bollards

Classic poles cast iron

Steel poles

MODERN POLES CAST IRON

Defence bollards

Drinkwater fountain

SEATING

TRAMWAY POLES

Modern LED luminaires

Classic luminaires

Classic street furniture

Ghm

Rue Antoine Durenne
52220 Sommevoire
France
Tel nr. 0033 3 25 55 23 03

ECLATEC

41 rue Lafayette
54320 Maxeville
France
Tel nr. 0033 3 83 39 38 28

Export internet : www.ghm-eclatec.com

Email export: info@ghm-eclatec.com